



Digital Night Vision Monocular  
HIKMICRO HEIMDAL Series

User Manual

## Legal Information

©2022 Hangzhou Microimage Software Co., Ltd. All rights reserved.

About this Manual

The Manual includes instructions for using and managing the Product. Pictures, charts, images and all other information hereinafter are for description and explanation only. The information contained in the Manual is subject to change, without notice, due to firmware updates or other reasons. Please find the latest version of this Manual at the HIKMICRO website ([www.hikmicrotech.com/](http://www.hikmicrotech.com/)).

Please use this Manual with the guidance and assistance of professionals trained in supporting the Product.

### Trademarks Acknowledgement

 **HIKMICRO** and other HIKMICRO's trademarks and logos are the properties of

HIKMICRO in various jurisdictions.

Other trademarks and logos mentioned are the properties of their respective owners.

### LEGAL DISCLAIMER

TO THE MAXIMUM EXTENT PERMITTED BY APPLICABLE LAW, THIS MANUAL AND THE PRODUCT DESCRIBED, WITH ITS HARDWARE, SOFTWARE AND FIRMWARE, ARE PROVIDED "AS IS" AND "WITH ALL FAULTS AND ERRORS". HIKMICRO MAKES NO WARRANTIES, EXPRESS OR IMPLIED, INCLUDING WITHOUT LIMITATION, MERCHANTABILITY, SATISFACTORY QUALITY, OR FITNESS FOR A PARTICULAR PURPOSE. THE USE OF THE PRODUCT BY YOU IS AT YOUR OWN RISK. IN NO EVENT WILL HIKMICRO BE LIABLE TO YOU FOR ANY SPECIAL, CONSEQUENTIAL, INCIDENTAL, OR INDIRECT DAMAGES, INCLUDING, AMONG OTHERS, DAMAGES FOR LOSS OF BUSINESS PROFITS, BUSINESS INTERRUPTION, OR LOSS OF DATA, CORRUPTION OF SYSTEMS, OR LOSS OF DOCUMENTATION, WHETHER BASED ON BREACH OF CONTRACT, TORT (INCLUDING NEGLIGENCE), PRODUCT LIABILITY, OR OTHERWISE, IN CONNECTION WITH THE USE OF THE PRODUCT, EVEN IF HIKMICRO HAS BEEN ADVISED OF THE POSSIBILITY OF SUCH DAMAGES OR LOSS.

YOU ACKNOWLEDGE THAT THE NATURE OF THE INTERNET PROVIDES FOR INHERENT SECURITY RISKS, AND HIKMICRO SHALL NOT TAKE ANY RESPONSIBILITIES FOR ABNORMAL OPERATION, PRIVACY LEAKAGE OR OTHER DAMAGES RESULTING FROM CYBER-ATTACK, HACKER ATTACK, VIRUS INFECTION, OR OTHER INTERNET SECURITY RISKS; HOWEVER, HIKMICRO WILL PROVIDE TIMELY TECHNICAL SUPPORT IF REQUIRED.

YOU AGREE TO USE THIS PRODUCT IN COMPLIANCE WITH ALL APPLICABLE LAWS, AND YOU ARE SOLELY RESPONSIBLE FOR ENSURING THAT YOUR USE CONFORMS TO THE APPLICABLE LAW. ESPECIALLY, YOU ARE RESPONSIBLE, FOR USING THIS PRODUCT IN A MANNER THAT DOES NOT INFRINGE ON THE RIGHTS OF THIRD PARTIES, INCLUDING WITHOUT LIMITATION, RIGHTS OF PUBLICITY, INTELLECTUAL PROPERTY RIGHTS, OR DATA PROTECTION AND OTHER PRIVACY RIGHTS. YOU SHALL NOT USE THIS PRODUCT FOR ILLEGAL HUNTING ANIMALS, INVASION OF PRIVACY OR ANY OTHER PURPOSE WHICH IS ILLEGAL OR DETRIMENTAL TO THE PUBLIC INTEREST. YOU SHALL NOT USE THIS PRODUCT FOR ANY PROHIBITED END-USES, INCLUDING THE DEVELOPMENT OR PRODUCTION OF WEAPONS OF MASS DESTRUCTION, THE DEVELOPMENT OR PRODUCTION OF

## Digital Night Vision Monocular User Manual

---

CHEMICAL OR BIOLOGICAL WEAPONS, ANY ACTIVITIES IN THE CONTEXT RELATED TO ANY NUCLEAR EXPLOSIVE OR UNSAFE NUCLEAR FUEL-CYCLE, OR IN SUPPORT OF HUMAN RIGHTS ABUSES.

IN THE EVENT OF ANY CONFLICTS BETWEEN THIS MANUAL AND THE APPLICABLE LAW, THE LATTER PREVAILS.

## Regulatory Information

### FCC Information

Please take attention that changes or modification not expressly approved by the party responsible for compliance could void the user's authority to operate the equipment.

FCC compliance: This equipment has been tested and found to comply with the limits for a Class B digital device, pursuant to part 15 of the FCC Rules. These limits are designed to provide reasonable protection against harmful interference in a residential installation. This equipment generates, uses and can radiate radio frequency energy and, if not installed and used in accordance with the instructions, may cause harmful interference to radio communications. However, there is no guarantee that interference will not occur in a particular installation. If this equipment does cause harmful interference to radio or television reception, which can be determined by turning the equipment off and on, the user is encouraged to try to correct the interference by one or more of the following measures:

- Reorient or relocate the receiving antenna.
- Increase the separation between the equipment and receiver.
- Connect the equipment into an outlet on a circuit different from that to which the receiver is connected.
- Consult the dealer or an experienced radio/TV technician for help

#### FCC Conditions

This device complies with part 15 of the FCC Rules. Operation is subject to the following two conditions:

1. This device may not cause harmful interference.
2. This device must accept any interference received, including interference that may cause undesired operation.

Note: Due to the device size limit, the above statement may not be disclaimed on the device. This equipment complies with FCC radiation exposure limits set forth for an uncontrolled environment.

### EU/UKCA Conformity Statement



This product and - if applicable - the supplied accessories too are marked with "CE" and comply therefore with the applicable harmonized European standards listed under the Directive 2014/30/EU (EMCD), Directive 2014/35/EU (LVD), Directive 2011/65/EU (RoHS).



This product and - if applicable - the supplied accessories too are marked with "UKCA" and comply therefore with the following directives: Radio Equipment Regulations 2017, Electromagnetic Compatibility Regulations 2016, Electrical Equipment (Safety) Regulations 2016, the Restriction of the Use of Certain Hazardous Substances in Electrical and Electronic Equipment Regulations 2012.

#### Frequency Bands and Power (for CE/UKCA)

The frequency bands and modes and the nominal limits of transmitted power (radiated and/or conducted) applicable to this radio device are the following: Wi-Fi 2.4 GHz (2.4 GHz to 2.4835 GHz), 20 dBm.



Directive 2012/19/EU (WEEE Directive): Products marked with this symbol cannot be disposed of as unsorted municipal waste in the European Union. For proper recycling, return this product to your local supplier upon the purchase of equivalent new equipment, or dispose of it at designated collection points. For more information see: [www.recyclethis.info](http://www.recyclethis.info)

According to the Waste Electrical and Electronic Equipment Regulations 2013: Products marked with this symbol cannot be disposed of as unsorted municipal waste in the United Kingdom. For proper recycling, return this product to your local supplier upon the purchase of equivalent new equipment, or dispose of it at designated collection points. For more information see: [www.recyclethis.info](http://www.recyclethis.info).



Directive 2006/66/EC and its amendment 2013/56/EU (Battery Directive): This product contains a battery that cannot be disposed of as unsorted municipal waste in the European Union. See the product documentation for specific battery information. The battery is marked with this symbol, which may include lettering to indicate cadmium (Cd), lead (Pb), or mercury (Hg). For proper recycling, return the battery to your supplier or to a designated collection point. For more information see: [www.recyclethis.info](http://www.recyclethis.info).

According to the Batteries and Accumulators (Placing on the Market) Regulations 2008 and the Waste Batteries and Accumulators Regulations 2009: This product contains a battery that cannot be disposed of as unsorted municipal waste in the United Kingdom. See the product documentation for specific battery information. The battery is marked with this symbol, which may include lettering to indicate cadmium (Cd), lead (Pb), or mercury (Hg). For proper recycling, return the battery to your supplier or to a designated collection point. For more information see: [www.recyclethis.info](http://www.recyclethis.info).

### Industry Canada ICES-003 Compliance

This device meets the CAN ICES-003 (B)/NMB-003(B) standards requirements.

This device complies with Industry Canada licence-exempt RSS standard(s). Operation is subject to the following two conditions:

- (1) this device may not cause interference, and
- (2) this device must accept any interference, including interference that may cause undesired operation of the device.

Le présent appareil est conforme aux CNR d'Industrie Canada applicables aux appareils radioexempts de licence. L'exploitation est autorisée aux deux conditions suivantes :

- (1) l'appareil ne doit pas produire de brouillage, et
- (2) l'utilisateur de l'appareil doit accepter tout brouillage radioélectrique subi, même si le

brouillage est susceptible d'en compromettre le fonctionnement.

This equipment complies with IC RSS-102 radiation exposure limits set forth for an uncontrolled environment.



ce matériel est conforme aux limites de dose d'exposition aux rayonnements, CNR-102 énoncée dans un autre environnement.

### **KC**

B급 기기: 이 기기는 가정용(B급) 전자파적합기기로서 주로 가정에서 사용하는 것을 목적으로 하며, 모든 지역에서 사용할 수 있습니다.

## Symbol Conventions

The symbols that may be found in this document are defined as follows.

Symbol	Description
 <b>Danger</b>	Indicates a hazardous situation which, if not avoided, will or could result in death or serious injury.
 <b>Caution</b>	Indicates a potentially hazardous situation which, if not avoided, could result in equipment damage, data loss, performance degradation, or unexpected results.
 <b>Note</b>	Provides additional information to emphasize or supplement important points of the main text.

## Safety Instruction

These instructions are intended to ensure that user can use the product correctly to avoid danger or property loss.

### Laws and Regulations

- Use of the product must be in strict compliance with the local electrical safety regulations.

### Transportation

- Keep the device in original or similar packaging while transporting it.
- Keep all wrappers after unpacking them for future use. In case of any failure occurred, you need to return the device to the factory with the original wrapper. Transportation without the original wrapper may result in damage on the device and the company shall not take any responsibilities.
- DO NOT drop the product or subject it to physical shock. Keep the device away from magnetic interference.

### Power Supply

- The input voltage for the device should meet the Limited Power Source (5 VDC, 2 A) according to the IEC62368 standard. Please refer to technical specifications for detailed information.
- Use the power adapter provided by qualified manufacturer. Refer to the product specification for detailed power requirements.
- Make sure the plug is properly connected to the power socket.
- DO NOT connect multiple devices to one power adapter, to avoid over-heating or fire hazards caused by overload.

### Battery

- Improper use or replacement of the battery may result in explosion hazard. Replace with the same or equivalent type only. The battery type is 18650 with the protection board, and the battery size should be within 19 mm × 70 mm. The rated voltage and capacity are 3.6 VDC/3.2 Ah. Dispose of used batteries in conformance with the instructions provided by the battery manufacturer.
- For long-term storage of the battery, make sure it is fully charged every half year to ensure the battery quality. Otherwise, damage may occur.
- Do not charge other battery types with the supplied charger. Confirm there is no flammable material within 2 m of the charger during charging.
- DO NOT place the battery near heating or fire source. Avoid direct sunlight.
- DO NOT swallow the battery to avoid chemical burns.
- DO NOT place the battery in the reach of children.
- The battery cannot be charged with external power source directly.

### Maintenance

- If the product does not work properly, please contact your dealer or the nearest service center.



We shall not assume any responsibility for problems caused by unauthorized repair or maintenance.

- Wipe the device gently with a clean cloth and a small quantity of ethanol, if necessary.
- If the equipment is used in a manner not specified by the manufacturer, the protection provided by the device may be impaired.
- It is recommended to reboot the device every 2 hours when using it to ensure the device performance.

### **Using Environment**

- Make sure the running environment meets the requirement of the device. The operating temperature shall be -20 °C to 50 °C (-4 °F to 122 °F), and the operating humidity shall be 95% or less.
- DO NOT expose the device to extremely hot, cold, dusty, corrosive, saline-alkali, or damp environments.
- This device can only be safely used in the region below 2000 meters above the sea level.
- Avoid equipment installation on vibratory surface or places subject to shock (neglect may cause equipment damage).
- DO NOT aim the lens at the sun or any other bright light.

### **Emergency**

- If smoke, odor, or noise arises from the device, immediately turn off the power, unplug the power cable, and contact the service center.

### **Manufacture Address**

Room 313, Unit B, Building 2, 399 Danfeng Road, Xixing Subdistrict, Binjiang District, Hangzhou, Zhejiang 310052, China  
Hangzhou Microimage Software Co., Ltd.

## Table of Contents

<b>Chapter 1 Overview</b> .....	<b>1</b>
<b>1.1 Device Description</b> .....	<b>1</b>
<b>1.2 Main Function</b> .....	<b>1</b>
<b>1.3 Appearance</b> .....	<b>1</b>
<b>Chapter 2 Preparation</b> .....	<b>3</b>
<b>2.1 Install Battery</b> .....	<b>3</b>
<b>2.2 Cable Connection</b> .....	<b>4</b>
<b>2.3 Power On/Off</b> .....	<b>4</b>
<b>2.4 Menu Description</b> .....	<b>5</b>
<b>Chapter 3 Image Settings</b> .....	<b>6</b>
<b>3.1 Adjust Focus</b> .....	<b>6</b>
<b>3.2 Adjust Beam Angle</b> .....	<b>6</b>
<b>3.3 Adjust Brightness</b> .....	<b>7</b>
<b>3.4 Adjust Contrast</b> .....	<b>7</b>
<b>3.5 Set Display Mode</b> .....	<b>7</b>
<b>3.6 Set EIS</b> .....	<b>7</b>
<b>3.7 Set Smart IR</b> .....	<b>8</b>
<b>3.8 Adjust Digital Zoom</b> .....	<b>8</b>
<b>3.9 Set OSD</b> .....	<b>8</b>
<b>3.10 Set Brand Logo</b> .....	<b>8</b>
<b>Chapter 4 Picture and Video</b> .....	<b>10</b>
<b>4.1 Capture Picture</b> .....	<b>10</b>
<b>4.2 Set Audio</b> .....	<b>10</b>
<b>4.3 Record Video</b> .....	<b>10</b>
<b>4.4 View Local Files</b> .....	<b>11</b>
<b>4.4.1 Delete Local Files</b> .....	<b>11</b>
<b>4.5 Export Files</b> .....	<b>11</b>
<b>Chapter 5 Client Software Connection</b> .....	<b>13</b>
<b>Chapter 6 System Settings</b> .....	<b>14</b>
<b>6.1 Synchronize Time</b> .....	<b>14</b>

# Digital Night Vision Monocular User Manual

---

<b>6.2 Language Settings</b> .....	14
<b>Chapter 7 Maintenance</b> .....	<b>15</b>
<b>7.1 View Device Information</b> .....	15
<b>7.2 Upgrade Device</b> .....	15
<b>7.3 Restore Device</b> .....	15
<b>Chapter 8 Frequently Asked Questions</b> .....	<b>16</b>
<b>8.1 Why is the monitor off?</b> .....	16
<b>8.2 The image is not clear, how to adjust it?</b> .....	16
<b>8.3 Capturing or recording fails. What's the problem?</b> .....	16
<b>8.4 Why the PC cannot identify the device?</b> .....	16
<b>Chapter 12 Appendix</b> .....	<b>17</b>
<b>12.1 Device Command</b> .....	17
<b>12.2 Device Communication Matrix</b> .....	17

## Chapter 1 Overview

### 1.1 Device Description

The digital night vision monocular can perform in all ambient light. It has an advanced HD sensor and a 1.39" AMOLED display, which provides full-color clarity in daytime and classic black & white viewing at night. The device meets the needs of various outdoor activities, including hiking, camping, bird watching, watching wildlife and scenery, sports, concerts, etc.

### 1.2 Main Function

- Display Mode: The device supports multiple display modes, and you can set day mode, night mode, defog mode, or auto mode according to the scene.
- Smart IR: The smart IR function helps to view targets clearly in dark environment.
- EIS: The EIS function keeps the image stable in live view mode and digital zoom process.
- Client Software Connection: The device can capture snapshots, record videos, and set parameters by HIKMICRO Sight App after being connected to your phone via hotspot.

### 1.3 Appearance

The appearance of digital night vision monocular is shown below. Please take the actual product for reference.

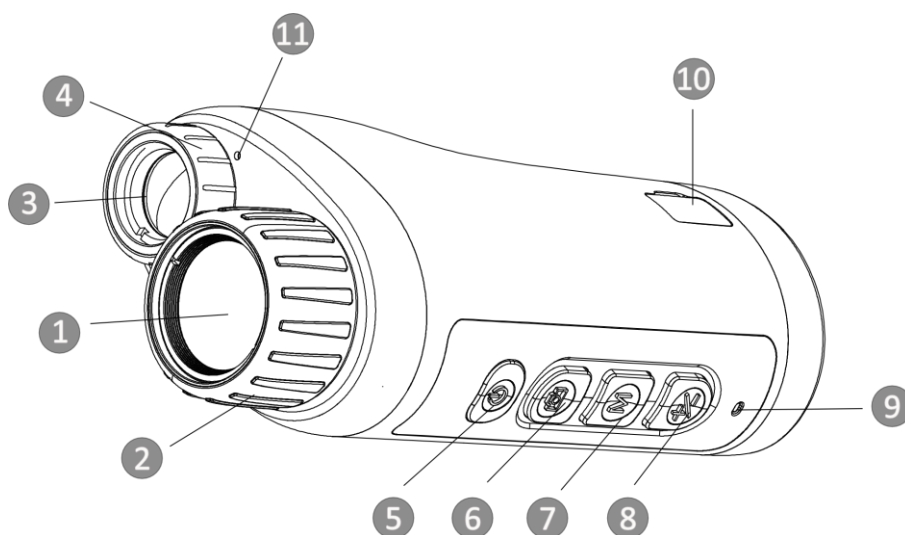

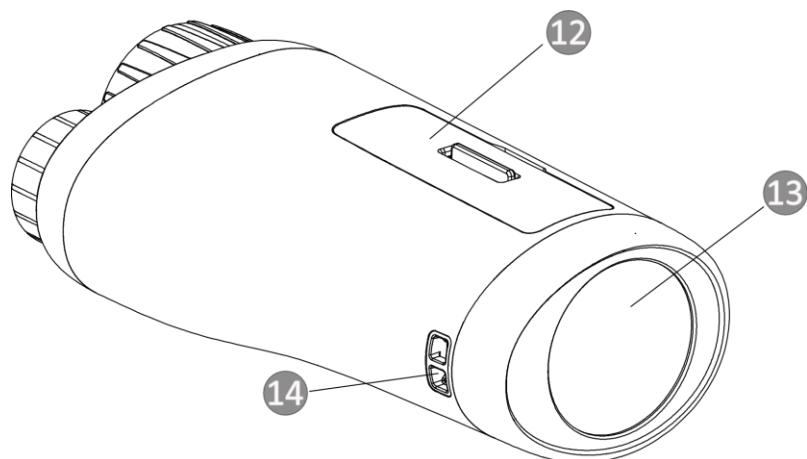

**Figure 1-1 Buttons and Interfaces**

**Table 1-1 Button and Interface Description**

No.	Component	Function
1	Optical Lens	Protect the lens.
2	Focus Ring	Adjust focus to find clear targets.
3	Infrared Light	Help to view target clearly in dark environment.
4	Beam Angle Adjustment Ring	Adjust the beam angle of the infrared light.
5	Power Key	<ul style="list-style-type: none"> <li>● Press: Standby mode/wake up device</li> <li>● Hold: Power on/off</li> </ul>
6	Capture Key	<ul style="list-style-type: none"> <li>● Press: capture</li> <li>● Hold: start/stop recording</li> </ul>
7	Mode Key	<ul style="list-style-type: none"> <li>● Press: switch display mode.</li> <li>● Hold: enter/exit menu.</li> </ul>
8	Zoom Key	Press to switch digital zoom.
9	Charging Indicator	Indicate the charging status of the device. <ul style="list-style-type: none"> <li>● Solid red: charging normally.</li> <li>● Solid green: Charging completed.</li> <li>● Flash green and red: charging exception.</li> </ul>
10	Type-C Interface	Charge the device and transmit data.
11	Microphone	Collect audio information.
12	Battery Compartment	Install battery in it.
13	Display Screen	Display live view and OSD information.
14	Wrist Strap Attachment Point	Mount the wrist strap.

## Chapter 2 Preparation

### 2.1 Install Battery

Insert the battery into the battery compartment.

#### Steps

1. Unlock the battery compartment cover.

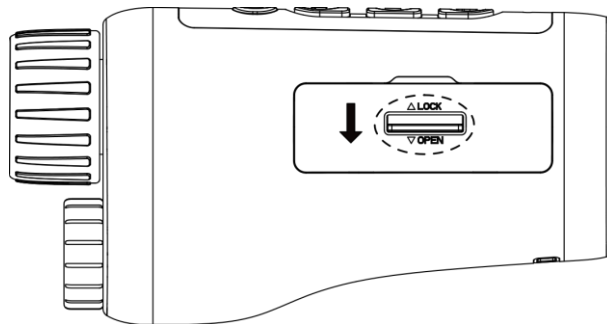

**Figure 2-1 Unlock Battery Compartment Cover**

2. Open the battery compartment cover.

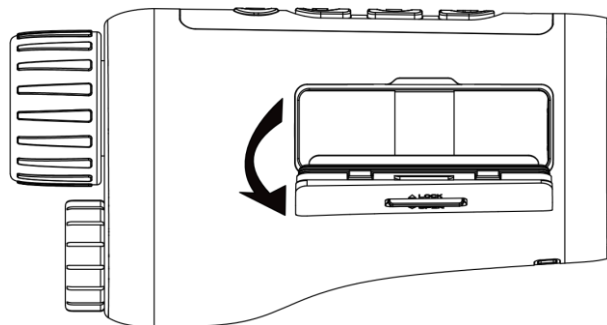

**Figure 2-2 Open Battery Compartment Cover**

3. Insert the battery into the battery compartment as the positive and negative marks indicate.

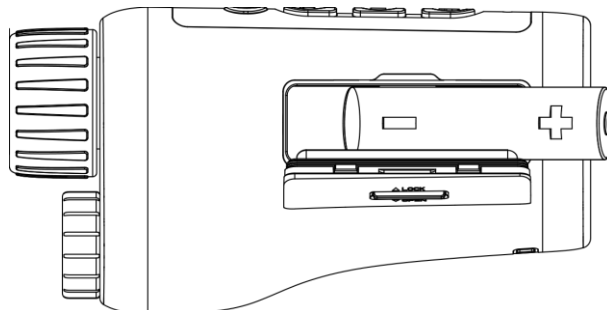

**Figure 2-3 Install Battery**

4. Close the battery compartment cover and lock it.

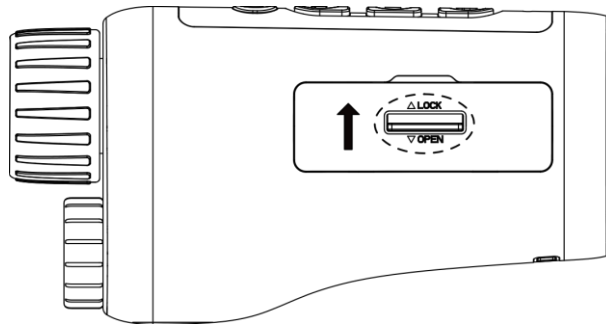

**Figure 2-4 Complete Installation**

---

**Note**

- Take the battery away if the device is not used for a long time.
  - Install the battery and charge the device for more than 4 hours before the first use.
- 

## 2.2 Cable Connection

Connect the device and power adaptor with a type-C cable to power on the device. Alternatively, connect the device and PC to export files.

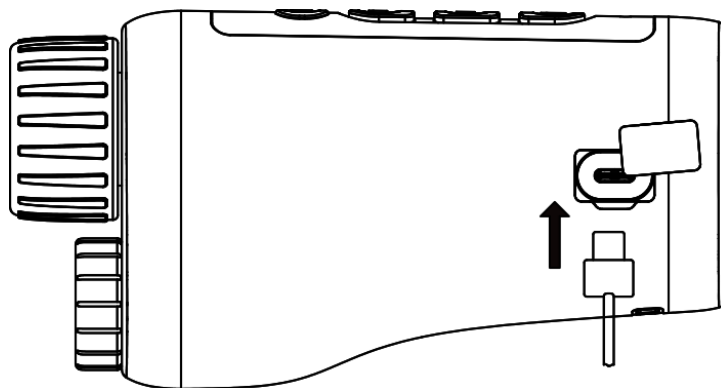

**Figure 2-5 Cable Connection**

## 2.3 Power On/Off

### Power On

When the battery is sufficiently charged, hold  for about 2 seconds to power on the device.

### Power Off

When the device is turned on, hold  for about 2 seconds to power off the device.

## Auto Power Off



Set the auto power off time for your device, and then the device will automatically shut down as the set time.

### Steps

1. Hold **M** to go to the menu.
2. Rotate the wheel to select **⏻**, and press **M** to select the auto power off time as required.
3. Hold **M** to save and exit.

---

### Note

- See the battery icon for the battery status.  means the battery is fully charged, and  means that the battery is low.
  - When the low power note shows, charge the battery.
  - The auto power off countdown will start again when the device exits standby mode, or the device is restarted.
- 

## 2.4 Menu Description

When the device is turned on, hold **M** to show the menu.



In the menu, you can press  and  to select functions, press **M** to configure the selected function, and hold **M** to exit the menu.



Figure 2-6 Menu Interface



## Chapter 3 Image Settings

### 3.1 Adjust Focus

Power on the device, and hold the device steadily, then rotate the focus ring to adjust the focus until the image is clear.

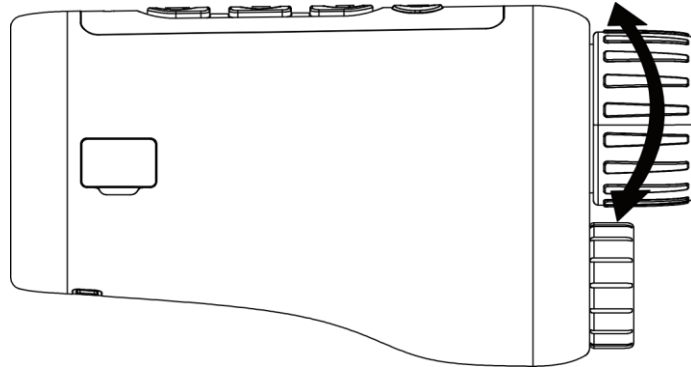

Figure 3-2 Adjust Focus

---

 **Note**

When adjusting focus, DO NOT touch the surface of lens to avoid smearing the lens.

---

### 3.2 Adjust Beam Angle

When you are in a dark environment, you can rotate the beam angle adjustment ring until the image is clear enough.

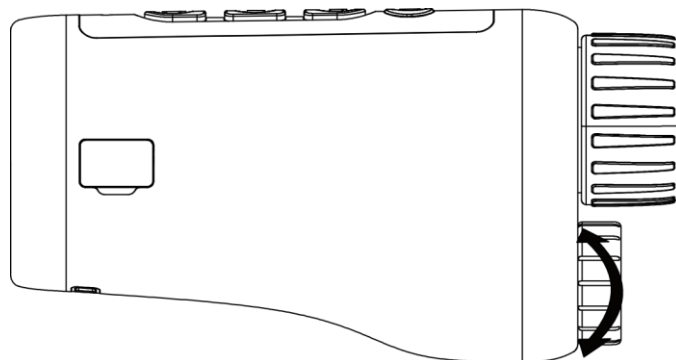





Figure 3-2 Adjust Beam Angle

### 3.3 Adjust Brightness

You can adjust the brightness for the image, and 10 levels of brightness can be adjusted.



#### Steps

1. Hold **M** to show the menu.
2. Select  and press **M** to enter the adjustment interface.
3. Press  or  to adjust the brightness.
4. Hold **M** to save and exit.

### 3.4 Adjust Contrast

You can adjust the contrast for the image, and 10 levels of contrast can be adjusted.





#### Steps

1. Hold **M** to show the menu.
2. Select  and press **M** to enter the adjustment interface.
3. Press  or  to adjust the brightness.
4. Hold **M** to save and exit.

### 3.5 Set Display Mode

You can select different display modes in different scenes.

Press **M** in live view interface to switch display modes. Day, night, defog, and auto are selectable.

-  : Day mode. You can use this mode at daytime and in bright environment. In day mode, the IR light is off automatically.
-  : Night mode. You can use this mode at nights and in bright environment. In day mode, the IR light is on automatically.
-  : Auto mode. The day mode and night mode switch automatically according to the ambient brightness.
-  : Defog mode. You can use this mode in foggy days.

### 3.6 Set EIS

The EIS (Electric Image Stabilization) function makes the image stable in live view mode and in the digital zoom process.

### Steps

1. Hold **M** to show the menu.
2. Select , and press **M** to enable this function.
3. Hold **M** to save and exit.

## 3.7 Set Smart IR

Image overexposure may occur in too bright environment. The smart IR function helps to adjust the overexposed images, and it can improve the image effect in night mode and dark environment.

In menu mode, select  and press **M** to enable this function.

## 3.8 Adjust Digital Zoom

You can zoom the image by using this function.

Press  in the view mode, the live view switches between 1 x, 2 x, 4 x, and 8 x.

---

### Note



This function varies according to different camera models.

---

## 3.9 Set OSD

You can choose whether to display the OSD information on the live view interface in this function.

### Steps

1. Hold **M** to show the menu.
2. Select , and press **M** to enter the OSD setting interface.
3. Press  or  to select the OSD information you want to display or not.
4. Press **M** to enable or disable the selected OSD information.
5. Hold **M** to save and exit.

## 3.10 Set Brand Logo

You can add brand logo on the live view interface.

### Steps

1. Hold **M** to show the menu.
2. Select .
3. Press **M** to enable **Brand Logo**.
4. Hold **M** to save the settings and exit.

### **Result**

The brand logo is displayed at the bottom of the image.

---

### **Note**

After enabling this function, the brand logo only displays on the live view interface, captures and videos.

---

## Chapter 4 Picture and Video

You can manually record video or capture picture when displaying live view.

### 4.1 Capture Picture

On the main live view page, press  to capture picture.

---

#### Note





When capturing succeeds, the image freezes for 1 second and a prompt shows on the display. For exporting captured pictures, refer to **Export Files**.

---

### 4.2 Set Audio

If you enable the audio function, the sound will be recorded with the video. When there is too loud noise in the video, you can disable this function.

#### Steps

1. Hold  to show the menu.
2. Select .
3. Press  to enable or disable this function.
4. Hold  to save and exit.

### 4.3 Record Video

#### Steps

1. In the main live view, hold  and start recording.

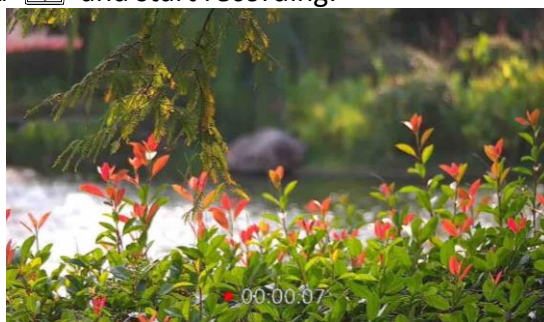

**Figure 4-1 Start Recording**

The bottom of the image displays the recording time.



2. Hold  again to stop recording.

## What to do next

For exporting recording files, refer to **Export Files**.

## 4.4 View Local Files

### Steps



1. Hold **M** to show the menu.
2. Select , and press **M** to enter the album interface.
3. Press  or  to select the target album.

---

### Note

The albums are automatically created and named by year + month. The local pictures and videos of a certain month are stored in the corresponding album. For example, the pictures and videos of August in 2022 are saved in the album named 202208.

---

4. Press **M** to enter the album, and press  or  to view the files.
5. (Optional) Press **M** to play the video on the device, and press **M** again to pause.

## What to do next

For exporting recording files, refer to **Export Files**.

### 4.4.1 Delete Local Files

You can delete files on the device.

### Steps

1. When viewing an unwanted image or video, double press **M**. A dialogue box pops up.
2. Press  or  to select **OK**, and press **M** to delete the file.
3. (Optional) Press  or  to select **CANCEL**, and press **M** to cancel the operation.

## 4.5 Export Files

This function is used to export recorded videos and captured pictures.

### Before You Start

- Turn off hotspot function.
- Turn on the device after connecting it to your PC, and keep the device on for 10 to 15 seconds before other operations.
- Remove batteries from the device before connecting to your PC, or it may cause device damage.

### Steps

1. Connect the device and PC with cable.

---

 **Note**

Make sure the device is turned on when connecting the cable.

---

2. Open computer disk and select the disk of device. Go to the **DCIM** folder and find the folder named after the capture year and month. For example, if you capture a picture or record a video on June 2021, go to **DCIM → 202106** to find the picture or video.
  3. Select and copy the files to PC.
  4. Disconnect the device from your PC.
- 

 **Note**

- The device displays images when you connect it to PC. But functions such as recording, capturing and hotspot are disabled.
  - When you connect the device to PC for the first time, it installs the drive program automatically.
-

## Chapter 5 Client Software Connection

Connect the device to the HIKMICRO Sight App via hotspot, then you can capture picture, record video, or configure parameters on your phone.

### Steps

1. Hold **M** to show the menu of device.
2. Select , and press **M** to enable hotspot function.
3. Turn on the WLAN of your phone and connect to the hotspot.
  - Hotspot Name: HIK-IPTS Serial No.
  - Hotspot Password: Serial No.
4. Search the HIKMICRO Sight App on App Store (iOS System) or Google Play™ (Android System) to download it, or scan the QR code to download and install the app.



Android System



iOS System

5. Open the App and connect your phone with the device. You can view the interface of device on your phone.

---

### Note

- The device cannot connect to the app if entering wrong password several times. Refer to **Restore Device** to reset the device, and connect the app again.
  - The device should be activated for the first use. The default password must be changed after the activation.
-













## Chapter 6 System Settings

You can set unit, time, and language for your device.

### 6.1 Synchronize Time







#### Steps

1. Hold  to show the menu.
2. Select , and press  to enter the time setting interface.
3. Press  to switch the time system, and press  or  to select the time and date to be synchronized.
4. Press  to select the hour, minute, second, year, month, or day to be synchronized, and press  or  again to change the number.
5. Hold  to save settings and exit.

### 6.2 Language Settings

You can select the device language in this function.

#### Steps



1. Hold  to show the menu.
2. Select , and press  to enter the language configuration interface.
3. Press  or  to select the language as required, and press  to confirm.

## Chapter 7 Maintenance

This part introduces the operation of checking device information, upgrading device, and restoring to defaults, etc.

### 7.1 View Device Information

#### Steps

1. Hold  to show the menu of device.
2. Select , and press . You can view the device information such as version, and serial No.

### 7.2 Upgrade Device

#### Before You Start

- Please get the upgrade package first.
- Make sure the hotspot function is disabled.
- Remove batteries from the device before connecting to your PC.
- Turn on the device after connecting it to your PC, and keep the device on for 10 to 15 seconds before other operations.

#### Steps

1. Connect the device to your PC with cable, and then turn on the device.
2. Open the detected disk, copy the upgrade file and paste it to the root directory of the device.
3. Hold  to reboot the device, and the device upgrades automatically. The upgrading process will be displayed in the main interface.

---

#### Note



During the upgrade, make sure the device is connected to your PC. Otherwise, it may cause unnecessary upgrade failure, firmware damage, etc.

---

4. Repeat the above steps to upgrade all firmware one by one.

### 7.3 Restore Device

#### Steps

1. Hold  to show the menu of device.
2. Select , and press  to restore the device to defaults according to the prompt.

## Chapter 8 Frequently Asked Questions

### 8.1 Why is the monitor off?

Check whether the device is off-battery. Connect the device to power supply and turn it on to check the monitor.

### 8.2 The image is not clear, how to adjust it?

Adjust the focus ring until the image is clear. Refer to section 3.1.

### 8.3 Capturing or recording fails. What's the problem?

Check the following items.

- Whether the device is connected to your PC. Capturing or recording is disabled in this status.
- Whether the storage space is full.
- Whether the device is low-battery.

### 8.4 Why the PC cannot identify the device?

Check the following items.

- Whether the device is connected to your PC with supplied USB cable.
- If you use other USB cables, make sure the cable length is no longer than 1 m.

## Chapter 12 Appendix

### 12.1 Device Command

Scan the following QR code to get device common serial port commands.

Note that the command list contains the commonly used serial port commands for HIKMICRO thermal cameras.



### 12.2 Device Communication Matrix

Scan the following QR code to get device communication matrix.

Note that the matrix contains all communication ports of HIKMICRO thermal cameras.





**HIKMICRO**

See the World in a New Way



Facebook: HIKMICRO Outdoor Instagram: hikmicro\_outdoor

YouTube: HIKMICRO Outdoor

LinkedIn: HIKMICRO