

HD Mini color camera

with HDMI interface

VC.3023

HIGHLIGHTS

- High definition 1080P color camera
- Real time images directly on TV, monitor or beamer
- Stand-alone
- Built-in mouse controlled software
- C-mount interface
- HDMI and SD memory card

TECHNICAL SPECIFICATIONS

Sensor	HDMI 2.0 Mega pixels CMOS high sensitive sensor (Sony)
Format	1/2.8 inch, HDTV 1080p
Pixels	1920 x 1080 pixels (capture mode) 1920 x 1080 pixels (live mode) HDMI 60 fps
Scan mode	Progressive scan
Pixel size	2.9 x 2.9 µm
Noise	3D Noise reduction function
Sensitivity	1300mv/lux-sec
Color rendering	12 Bits
Signal/Noise (db)	42
Dynamic (db)	69
White balance	Automatic/manual/ROI
Interface	HDMI
Storage	Images are saved to a standard high speed 16 GB SD memory card (Recommend using SD card of class 4 or higher and ≤128 GB)
Mounting	C-mount interface
Power supply	DC 12V/ 1A adapter
Operation	-10~ 50 Celsius, 30~80%RH
Storage	-20~ 60 Celsius, 10~60%RH
Supplied with	HDMI cable, DC 12V/ 1A power supply, 16 GB SD Card, USB mouse, 0.5x c-mount adapter, 23.2~30.0/ 30.5mm adapter rings



● VC.3023

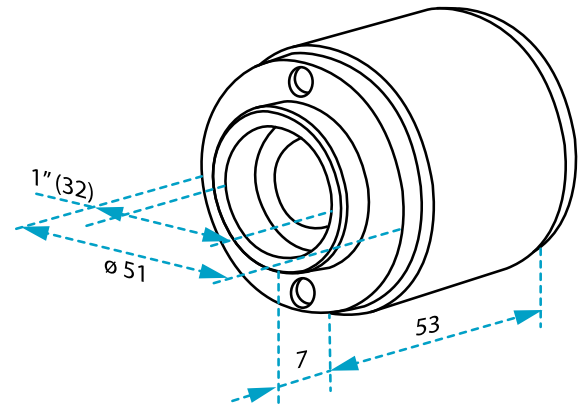

ON SCREEN CONTROLS (NO NEED FOR COMPUTER)

- Capture images and video to SD
- Digital zoom in/out
- Mirror/Flip
- Freeze
- Cross line
- Embedded file browser
- Video playback
- Multiple language support
- Measurement
- Camera settings (white balance, color control etc)

Compatibility Suitable for all HDMI screens, monitors and beamers

Product number VC.3023

MODELS	Sensor	Pixel size (µm)	Resolution	Noise	Sensitivity	Color rendering (bits)	Dynamic (db)	11.6 HD screen
VC.3023	1/2.8 inch	2.9 x 2.9 µm	1920 x 1080	3D Noise reduction	1300mv/lux-sec	12	69	--
VC.3024-HDS	1/2.8 inch	2.9 x 2.9 µm	1920 x 1080	3D Noise reduction	1300mv/lux-sec	12	69	•